

AREA 4815X

PROJECT PROJÉT
SPEC TYPE
NOTES



FINISH FINI



BLKE

WHE

LGE

FAMILY FAMILLE



4715 (WALL SURFACE)

4715 (CEILING SURFACE)

4816X

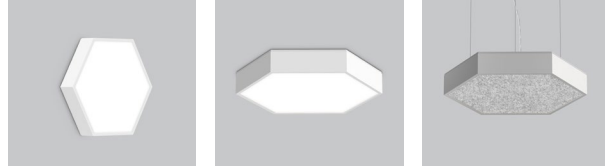

4720 (WALL SURFACE)

4720 (CEILING SURFACE)

4821

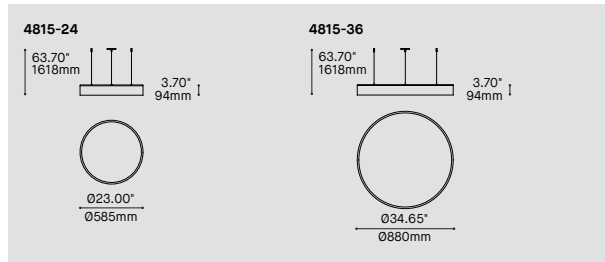

ORDERING SPECIFICATION SPÉCIFICATION DE COMMANDE

CODE

MODEL MODÈLE	
4815D-24	AREA 24" – DIRECT
4815D-36	AREA 36" – DIRECT
4815DI-24	AREA 24" – DIRECT INDIRECT
4815DI-36	AREA 36" – DIRECT INDIRECT

LIGHT SOURCE SOURCE LUMINEUSE

4815D	
LED.LO	LOW OUTPUT
LED	REGULAR OUTPUT
LED.HO	HIGH OUTPUT
4815DI	
LED.C1	REGULAR OUTPUT DIRECT + REGULAR OUTPUT INDIRECT
LED.C2	HIGH OUTPUT DIRECT + HIGH OUTPUT INDIRECT
LED.C3	REGULAR OUTPUT DIRECT + HIGH OUTPUT INDIRECT
LED.C4	HIGH OUTPUT DIRECT + REGULAR OUTPUT INDIRECT

COLOR TEMPERATURE TEMPÉRATURE DE COULEUR

27	2700K
30	3000K
35	3500K
40*	4000K

* LONGER LEAD TIME MAY APPLY. PLEASE CONTACT YOUR EUREKA REPRESENTATIVE

COLOR RENDERING INDEX (CRI) INDICE DE RENDU DE COULEUR (IRC)

90	90+ CRI	90
----	---------	----

VOLTAGE VOLTAGE

120V	120 VOLT
277V	277 VOLT

CONTROL OPTION OPTION DE CONTRÔLE

DV	0-10V DIMMING (120V-277V)
DP	PHASE DIMMING (120V ONLY)
NLTAIR2*	NLIGHT AIR CONTROL GEN 2
NLIGHT*	NLIGHT WIRED CONTROL

* NLIGHT WIRED INTEGRATION REQUIRES A REMOTE POWER PACK (39NLWA).
 * EMERGENCY BATTERY NOT AVAILABLE WITH NLIGHT OPTIONS
 REFER TO NLIGHT GUIDE AND INSTALLATION SHEET FOR ALL REQUIREMENTS.

EMERGENCY BATTERY BATTERIE D'URGENCE

EM	EMERGENCY BATTERY
----	-------------------

CABLE CABLE

AC	AIRCRAFT MOUNTING & CLEAR CABLE, FIELD ADJUSTABLE	AC
----	---	----

CABLE LENGTH LONGUEUR DE CÂBLE

60	60" AIRCRAFT CABLE (STD LENGTH)
**	CUSTOM AIRCRAFT CABLE LENGTH (PLEASE SPECIFY) FOR OVERALL LENGTH, PLEASE CONTACT YOUR EUREKA REPRESENTATIVE

MOUNTING CABLE OPTION OPTION DE MONTAGE DE CÂBLE

RCA *	CENTERED ROUND CANOPY – AIRCRAFT CABLES ANGLED TO CENTER IF NO OPTION IS SELECTED, AN OFF-CENTERED ROUND CANOPY WITH STRAIGHT AIRCRAFT CABLES IS STANDARD
-------	--

CANOPY FINISH FINI PAVILLON

BLKE	BLACK FINE TEXTURE
WHE	WHITE FINE TEXTURE

HOUSING FINISH FINI BOITIER

BLKE	BLACK FINE TEXTURE
WHE	WHITE FINE TEXTURE
LGE	LIGHT GREY FINE TEXTURE
RAL*	PLEASE SPECIFY RAL CODE LONGER LEAD TIME MAY APPLY, PLEASE CONTACT YOUR EUREKA REPRESENTATIVE

DIFFUSER FINISH FINI DIFFUSEUR

WHE	WHITE	WH
-----	-------	----

ACCESSORY ACCESSOIRE

ALL ACCESSORIES ARE AVAILABLE FOR ADVANCE SHIPPING

39NLAA*	NLIGHT AIR GEN 2 REMOTE POWER PACK
39NLWA*	NLIGHT WIRED REMOTE POWER PACK

*FOR CHICAGO PLENUM INSTALLATION, PLEASE CONTACT YOUR EUREKA REPRESENTATIVE.

PRODUCT CHARACTERISTICS CARACTÉRISTIQUES DU PRODUIT



AREA 4815X

QUICKSHIP

PROJECT PROJET

SPEC TYPE

NOTES

4815-24



4815-36



FAMILY FAMILLE



4715 (WALL SURFACE)



4715 (CEILING SURFACE)



4816X



4720 (WALL SURFACE)

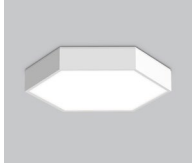

4720 (CEILING SURFACE)



4821

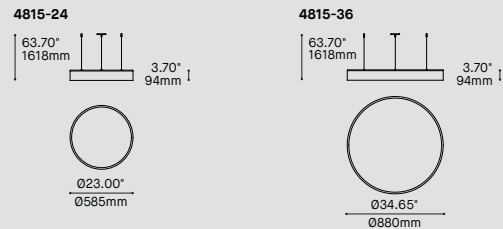

ORDERING SPECIFICATION SPÉCIFICATION DE COMMANDE

CODE

QUICKSHIP

QS5 QUICKSHIP 5 DAYS - MAXIMUM 5 UNITS QUICKSHIP 5 JOURS - MAXIMUM 5 UNITÉS
 QS10 QUICKSHIP 10 DAYS - MAXIMUM 20 UNITS QUICKSHIP 10 JOURS - MAXIMUM 20 UNITÉS

MODEL MODÈLE

4815D-24 AREA 24" - DIRECT
 4815D-36 AREA 36" - DIRECT
 4815DI-24 AREA 24" - DIRECT INDIRECT
 4815DI-36 AREA 36" - DIRECT INDIRECT

LIGHT SOURCE SOURCE LUMINEUSE

4815D
 LED.LO LOW OUTPUT
 LED REGULAR OUTPUT
 LED.HO HIGH OUTPUT

4815DI
 LED.C1 REGULAR OUTPUT DIRECT + REGULAR OUTPUT INDIRECT
 LED.C2 HIGH OUTPUT DIRECT + HIGH OUTPUT INDIRECT
 LED.C3 REGULAR OUTPUT DIRECT + HIGH OUTPUT INDIRECT
 LED.C4 HIGH OUTPUT DIRECT + REGULAR OUTPUT INDIRECT

COLOR TEMPERATURE TEMPÉRATURE DE COULEUR

30 3000K
 35 3500K

COLOR RENDERING INDEX (CRI) INDICE DE RENDU DE COULEUR (IRC)

90 90+ CRI

VOLTAGE VOLTAGE

120V 120 VOLT
 277V 277 VOLT

CONTROL OPTION OPTION DE CONTRÔLE

DV 0-10V DIMMING (120V-277V)
 DP PHASE DIMMING (120V ONLY)

CABLE CABLE

AC AIRCRAFT MOUNTING & CLEAR CABLE, FIELD ADJUSTABLE

CABLE LENGTH LONGUEUR DE CÂBLE

60 60" AIRCRAFT CABLE (STD LENGTH)
 ** CUSTOM AIRCRAFT CABLE LENGTH (PLEASE SPECIFY)
 FOR OVERALL LENGTH, PLEASE CONTACT YOUR EUREKA REPRESENTATIVE

MOUNTING CABLE OPTION OPTION DE MONTAGE DE CÂBLE

RCA * CENTERED ROUND CANOPY - AIRCRAFT CABLES ANGLED TO CENTER
 IF NO OPTION IS SELECTED, AN OFF-CENTERED ROUND CANOPY WITH STRAIGHT AIRCRAFT CABLES IS STANDARD

CANOPY FINISH FINI PAVILLON

WHE WHITE FINE TEXTURE

HOUSING FINISH FINI BOITIER

WHE WHITE FINE TEXTURE

DIFFUSER FINISH FINI DIFFUSEUR

WHE WHITE

PRODUCT CHARACTERISTICS CARACTÉRISTIQUES DU PRODUIT

ADA BIM DIM IES LED

AREA 4815

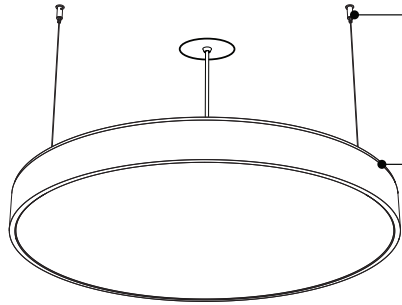

SIMPLIFIED INSTALLATION
Position 3 steel aircraft cables anywhere around a junction box in the center (RCA)
Easy leveling with adjustable cable grippers

SIMPLE AND CLEAN HOUSING
Precision welded aluminium extrusion
Clean geometry on the outside, structural details on the inside

4815-36 / 4815I-36

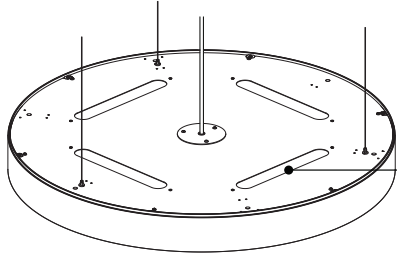

INDIRECT LIGHTING
Dedicated LED indirect lighting modules (4815DI)
Minimum suspension height of 18" (4815DI)
Powder-coated steel covers (4815D)

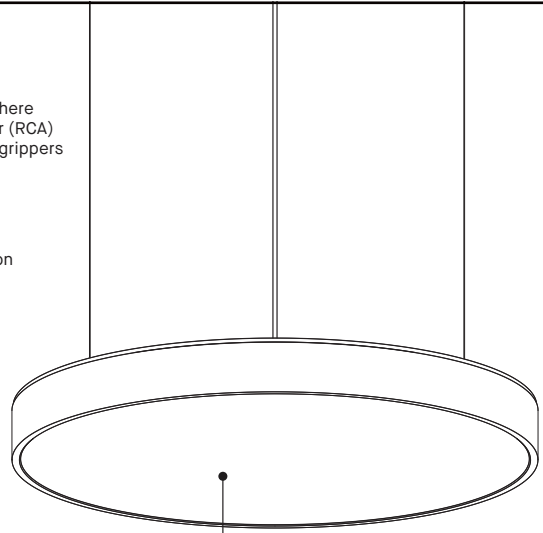

LENS
High performance frosted acrylic lens for superior light transmission

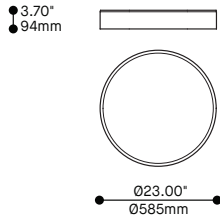

4815-24 / 4815I-24

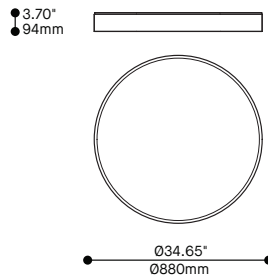

4815-36 / 4815I-36



Also available in acoustic version
See product 4816

PRODUCT SPECIFICATION

	4815D-24	4815D-36	4815DI-24	4815DI-36
PERFORMANCE	LO/REG/HO	LO/REG/HO	REG/HO	REG/HO
SYSTEM WATTAGE	17.3W/35.8W / 44.5W	38.2W/86.7W / 110.1W	55.5W / 84W	112.2W / 162.3W
DELIVERED DIRECT LUMENS (4000K)	1876LM/3400LM / 4120LM	4394LM/8673LM / 10701LM	3400LM / 4120LM	8435LM / 10701LM
DELIVERED INDIRECT LUMENS (4000K)	-	-	2348LM / 4697LM	3089LM / 6179LM
EFFICACY	95LM/W	100LM/W	61LM/W	75LM/W
OTHER INFORMATIONS				
WEIGHT	15.6LBS / 7.1KG	34.1LBS / 15.5KG	16.5LBS / 7.5KG	35.0LBS / 15.9KG
L70 (LUMEN MAINTENANCE)	> 60 000 HRS	> 60 000 HRS	> 60 000 HRS	> 60 000 HRS
DUAL CIRCUIT DIMMING	-	-	YES	YES
MAX. LUMINANCE 45°-90° OF NADIR	3259 CD/M ² (HO)	3936 CD/M ² (HO)	3259 CD/M ² (HO)	3936 CD/M ² (HO)
LIGHT QUALITY	R9 > 50 (90 CRI OPTION)			

EFFICACY MULTIPLIERS

CRI	CCT	FACTOR
90+	4000K	1.00
90+	3500K	0.96
90+	3000K	0.92
90+	2700K	0.87

LIGHT DISTRIBUTION

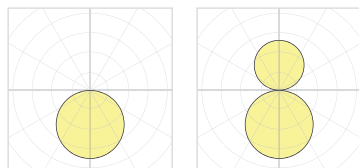

4815D-XX

4815DI-XX



Visit our website for warranty terms and conditions.



TECHNICAL DATA

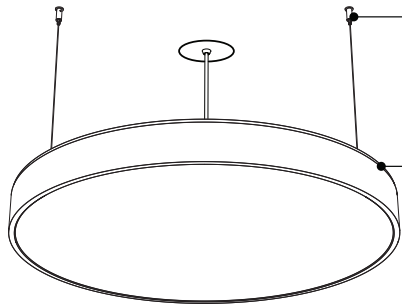

INSTALLATION SIMPLIFIÉE

Situer les 3 câbles de suspension n'importe où autour de la boîte de connexion ou au centre (RCA)
Mise à niveau et équilibrage rapide avec serre câbles ajustables

BOÎTIER SOBRE

Extrusion d'aluminium soudée avec précision
Lignes nettes et modernes à l'extérieur, détails structuraux cachés à l'intérieur

4815-36 / 4815I-36

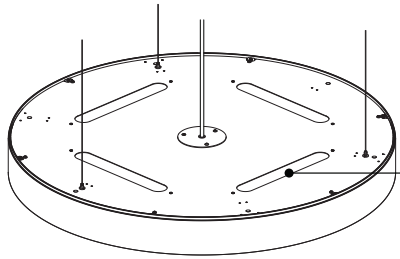

ÉCLAIRAGE INDIRECT

Module LED d'éclairage indirect (4815DI)
Suspension minimum de 18" (4815DI)
Plaquettes en acier peintes (4815D)

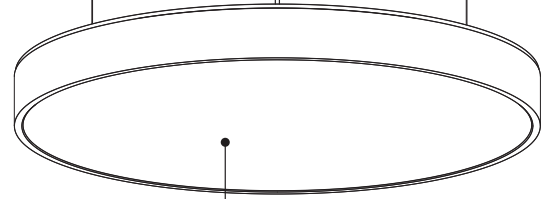

LENTILLE

Lentille d'acrylique givrée haute performance permet une transmission optique supérieure

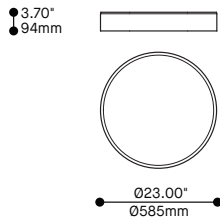

4815-24 / 4815I-24

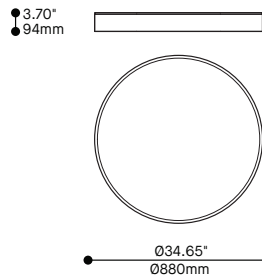

4815-36 / 4815I-36



Aussi disponible en version acoustique
Voir le produit 4816

SPÉCIFICATION PRODUIT

	4815D-24	4815D-36	4815DI-24	4815DI-36
PERFORMANCE	LO/REG/HO	LO/REG/HO	REG/HO	REG/HO
PUISSANCE TOTALE	17.3W/35.8W / 44.5W	38.2W/86.7W / 110.1W	55.5W / 84W	112.2W / 162.3W
LUMENS RÉELS DIRECT (4000K)	1876LM/3400LM / 4120LM	4394LM/8673LM / 10701LM	3400LM / 4120LM	8435LM / 10701LM
LUMENS RÉELS INDIRECT (4000K)	-	-	2348LM / 4697LM	3089LM / 6179LM
EFFICACITÉ	95LM/W	100LM/W	61LM/W	75LM/W
AUTRES INFORMATIONS				
POIDS	15.6LBS / 7.1KG	34.1LBS / 15.5KG	16.5LBS / 7.5KG	35.0LBS / 15.9KG
L70 (LUMEN MAINTENANCE)	> 60 000 H	> 60 000 H	> 60 000 H	> 60 000 H
GRADATION DOUBLE CIRCUIT	-	-	OUI	OUI
MAX. LUMINANCE 45°-90° NADIR	3259 CD/M ² (HO)	3936 CD/M ² (HO)	3259 CD/M ² (HO)	3936 CD/M ² (HO)
QUALITÉ DE LA LUMIÈRE	R9 > 50 (OPTION 90 IRC)			

FACTEURS D'EFFICACITÉ

CRI	CCT	FACTEUR
90+	4000K	1.00
90+	3500K	0.96
90+	3000K	0.92
90+	2700K	0.87

DISTRIBUTION LUMINEUSE

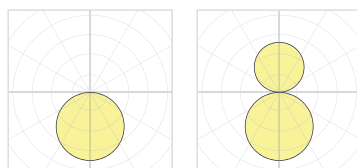

4815D-XX

4815DI-XX



VisiteznotresiteWebpourlestermesetconditions.